

J50S

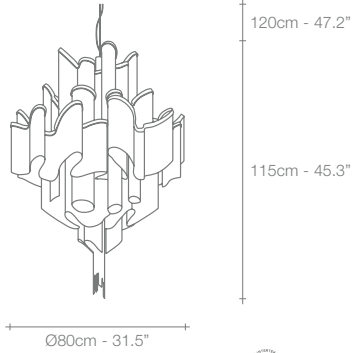

J51S

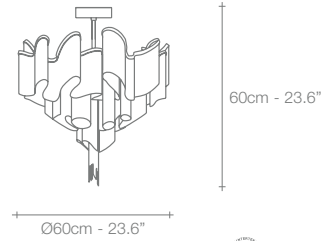

J70L

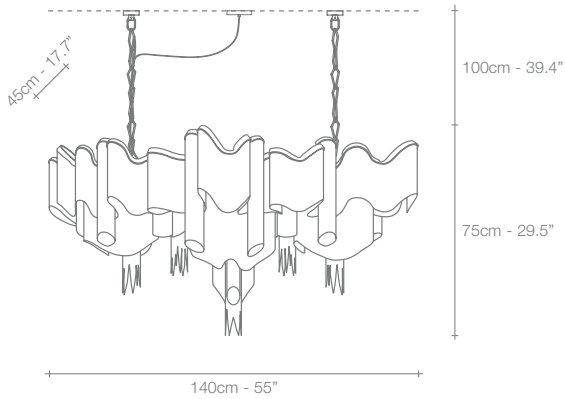

J52S

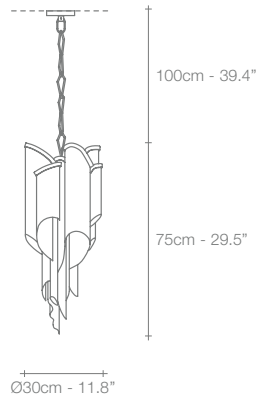

J54S

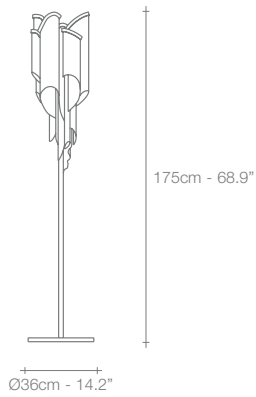



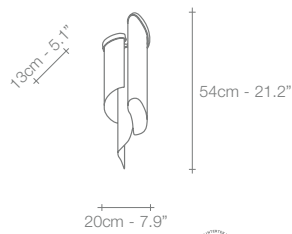





J65P





J60A



NICKEL

230V		+		J50S 20X28W E14 (=20x40W) + 35W GU10	J51S 18X28W E14 (=18x40W) + 35W GU10		+		J52S 12X33W G9 (=12X40W) + 3X35W GU10	J54S 4X33W G9 (=4X40W) + 35W GU10	J70L 8X33W G9 (=8X40W) + 35W GU10
	120V		+		20X40W E12 + 35W GU10	18X40W E12 + 35W GU10		+		12X35W G9 + 3X35W GU10	4X35W G9 + 35W GU10

	J60A 2X42W (=2x60W)	J65P 6X28W (=6x40W)
	2X60W	6X40W

LED LIGHT BULBS MAY BE USED