

*Maniglioni e
battiporta*
Pulls and door knockers

Busiri

maniglioni pulls

materiale: ottone
material: brass

KBU16

Ottone naturale non verniciato
Natural brass not lacquered

Ottone lucido verniciato
Lacquered polished brass

Bronzo non verniciato
Bronze not lacquered

Argento naturale non verniciato
Natural silver not lacquered

Cromo
Chrome

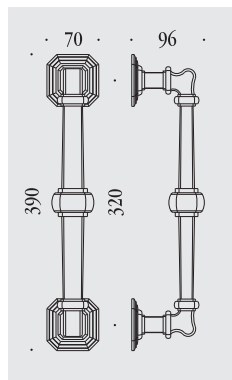

Ottone naturale non verniciato
Natural brass not lacquered



KBU26 NP

Ottone naturale non verniciato
Natural brass not lacquered

Ottone lucido verniciato
Lacquered polished brass

Bronzo non verniciato
Bronze not lacquered

Argento naturale non verniciato
Natural silver not lacquered

Cromo
Chrome

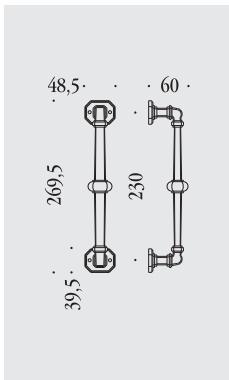

Ottone naturale non verniciato
Natural brass not lacquered

KBU26 PS

Ottone naturale non verniciato
Natural brass not lacquered

Ottone lucido verniciato
Lacquered polished brass

Bronzo non verniciato
Bronze not lacquered

Argento naturale non verniciato
Natural silver not lacquered

Cromo
Chrome

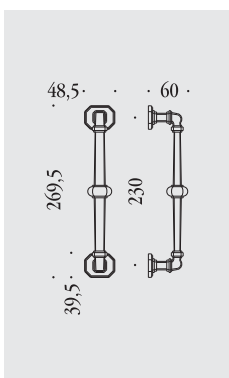

Bronzo non verniciato
Bronze not lacquered



Byblos

*maniglioni
pulls*

*materiale: ottone
material: brass*

KBY16

Ottone lucido verniciato
Lacquered polished brass

Bronzo satinato verniciato
Lacquered satin bronze

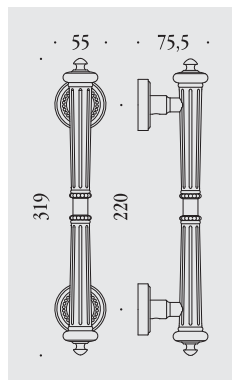

Bronzo satinato verniciato
Lacquered satin bronze



KBY16 NP

Ottone lucido verniciato
Lacquered polished brass

Bronzo satinato verniciato
Lacquered satin bronze

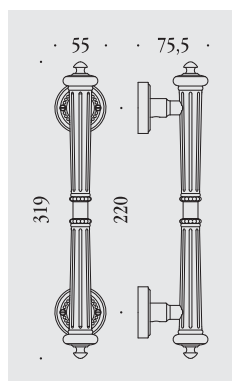

Byblos

*maniglioni
pulls*

*materiale: ottone
material: brass*



KBY26

Ottone lucido verniciato
Lacquered polished brass

Bronzo satinato verniciato
Lacquered satin bronze

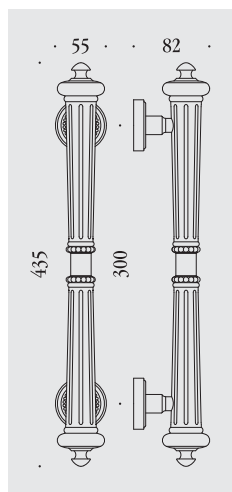

Ottone lucido verniciato
Lacquered polished brass

KBY26 NP

Ottone lucido verniciato
Lacquered polished brass

Bronzo satinato verniciato
Lacquered satin bronze

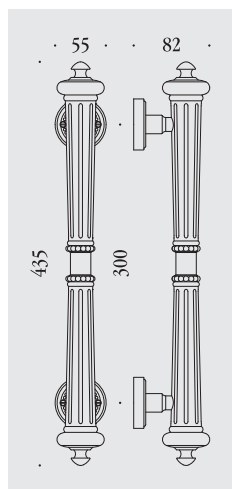

Capri

*maniglioni
pulls*

*materiale: ottone
material: brass*

KCR16

Ottone naturale non verniciato
Natural brass not lacquered

Bronzo non verniciato
Bronze not lacquered

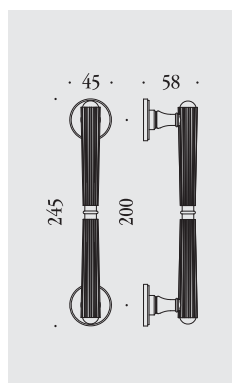

Ottone naturale non verniciato
Natural brass not lacquered



Capri

*maniglioni
pulls*

*materiale: ottone
material: brass*



KCR26

Ottone naturale non verniciato
Natural brass not lacquered

Bronzo non verniciato
Bronze not lacquered

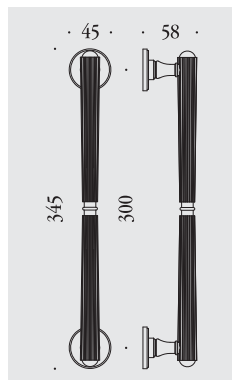

Bronzo non verniciato
Bronze not lacquered

Impero

*maniglioni
pulls*

*materiale: ottone
material: brass*

KIM16

Ottone naturale non verniciato
Natural brass not lacquered

Ottone lucido verniciato
Lacquered polished brass

Bronzo non verniciato
Bronze not lacquered

Argento naturale non verniciato
Natural silver not lacquered

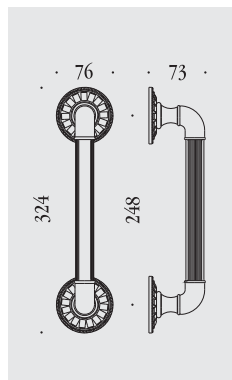

Ottone naturale non verniciato
Natural brass not lacquered



Impero

*maniglioni
pulls*

*materiale: ottone
material: brass*

KIM26

Ottone naturale non verniciato
Natural brass not lacquered

Ottone lucido verniciato
Lacquered polished brass

Bronzo non verniciato
Bronze not lacquered

Argento naturale non verniciato
Natural silver not lacquered

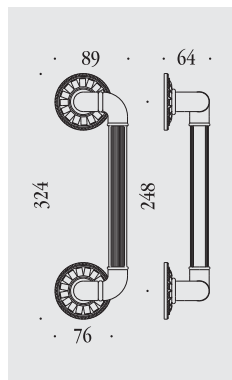

Ottone naturale non verniciato
Natural brass not lacquered



Louis XVI

maniglioni pulls

materiale: ottone
material: brass

KLU16 NP

Ottone naturale non verniciato
Natural brass not lacquered

Ottone lucido verniciato
Lacquered polished brass

Bronzo non verniciato
Bronze not lacquered

Argento naturale non verniciato
Natural silver not lacquered

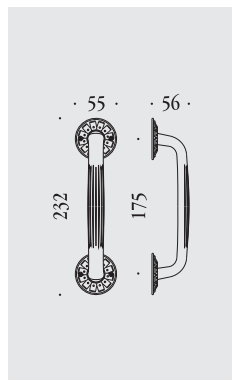

Ottone naturale non verniciato
Natural brass not lacquered

KLU16 PS

Ottone naturale non verniciato
Natural brass not lacquered

Ottone lucido verniciato
Lacquered polished brass

Bronzo non verniciato
Bronze not lacquered

Argento naturale non verniciato
Natural silver not lacquered

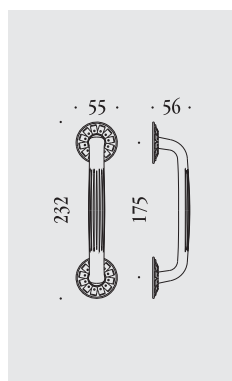

Louis XVI

*maniglioni
pulls*

*materiale: ottone
material: brass*

KLU26 NP

Ottone naturale non verniciato
Natural brass not lacquered

Ottone lucido verniciato
Lacquered polished brass

Bronzo non verniciato
Bronze not lacquered

Argento naturale non verniciato
Natural silver not lacquered

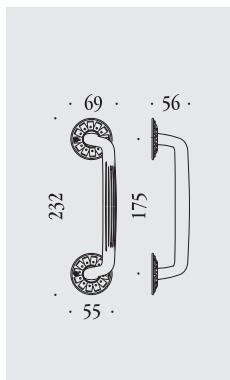

Ottone naturale non verniciato
Natural brass not lacquered

KLU26 PS

Ottone naturale non verniciato
Natural brass not lacquered

Ottone lucido verniciato
Lacquered polished brass

Bronzo non verniciato
Bronze not lacquered

Argento naturale non verniciato
Natural silver not lacquered

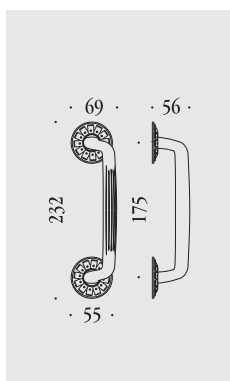

Ottocento

maniglioni pulls

materiale: ottone
material: brass

KOT16

Ottone naturale non verniciato
Natural brass not lacquered

Bronzo non verniciato
Bronze not lacquered

Argento naturale non verniciato
Natural silver not lacquered

Nichel naturale non verniciato
Natural nickel not lacquered

Ottone lucido verniciato
Lacquered polished brass

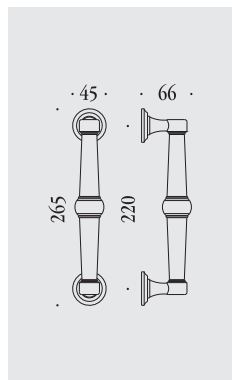

Ottone naturale non verniciato
Natural brass not lacquered



Ottocento

*maniglioni
pulls*

*materiale: ottone
material: brass*

KOT26

Ottone naturale non verniciato
Natural brass not lacquered

Bronzo non verniciato
Bronze not lacquered

Argento naturale non verniciato
Natural silver not lacquered

Nichel naturale non verniciato
Natural nickel not lacquered

Ottone lucido verniciato
Lacquered polished brass

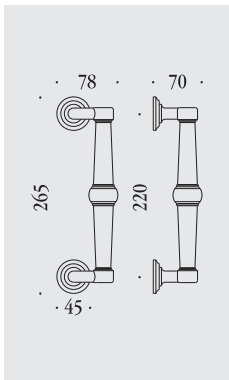

Ottone naturale non verniciato
Natural brass not lacquered



Venezia

*maniglioni
pulls*

*materiale: ottone
material: brass*

KVE16

Ottone naturale non verniciato
Natural brass not lacquered

Bronzo non verniciato
Bronze not lacquered

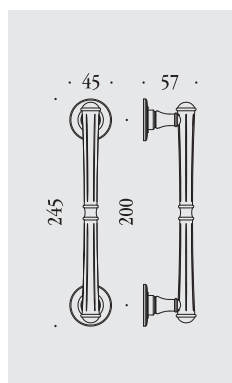

Bronzo non verniciato
Bronze not lacquered



Venezia

*maniglioni
pulls*

*materiale: ottone
material: brass*



KVE26

Ottone naturale non verniciato
Natural brass not lacquered

Bronzo non verniciato
Bronze not lacquered

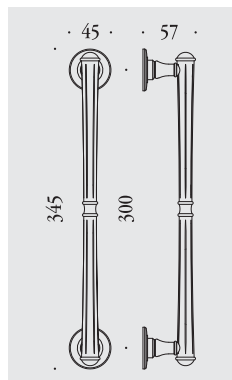

Ottone naturale non verniciato
Natural brass not lacquered

Vitto

maniglioni pulls

materiale: ottone
material: brass

KOT36

Ottone naturale non verniciato
Natural brass not lacquered

Ottone lucido verniciato
Lacquered polished brass

Bronzo non verniciato
Bronze not lacquered

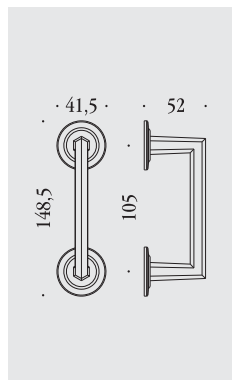

Bronzo non verniciato
Bronze not lacquered



Busiri

maniglioni per alzante scorrevole
pull-up handles for sliding door

materiale: ottone
material: brass

KBU113

Ottone naturale non verniciato
Natural brass not lacquered

Bronzo non verniciato
Bronze not lacquered

Argento naturale non verniciato
Natural silver not lacquered

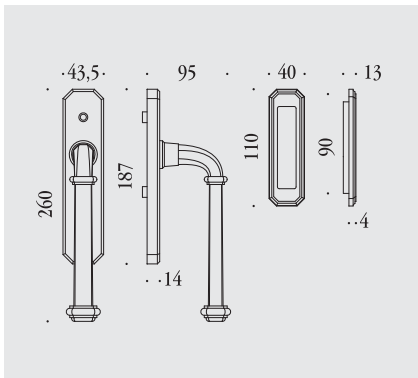

Ottone naturale non verniciato
Natural brass not lacquered



Impero

maniglioni per alzante scorrevole
pull-up handles for sliding door

materiale: ottone
material: brass

KIM113

Ottone naturale non verniciato
Natural brass not lacquered

Bronzo non verniciato
Bronze not lacquered

Argento naturale non verniciato
Natural silver not lacquered

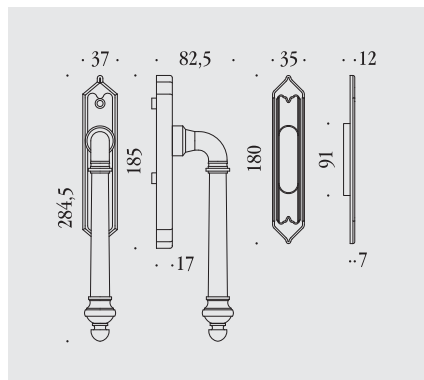

Ottone naturale non verniciato
Natural brass not lacquered



Louis XVI

maniglioni per alzante scorrevole
pull-up handles for sliding door

materiale: ottone
material: brass

KLU113

Ottone naturale non verniciato
Natural brass not lacquered

Bronzo non verniciato
Bronze not lacquered

Argento naturale non verniciato
Natural silver not lacquered

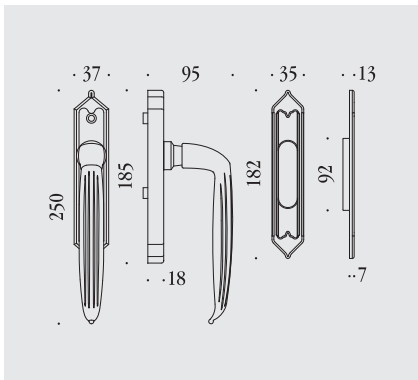

Ottone naturale non verniciato
Natural brass not lacquered



Ottocento

battiporta *door knockers*

materiale: ottone
material: brass

KOT115

Ottone naturale non verniciato
Natural brass not lacquered

Bronzo non verniciato
Bronze not lacquered

Argento naturale non verniciato
Natural silver not lacquered

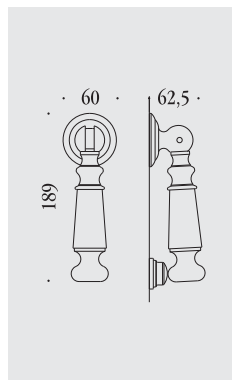

Ottone naturale non verniciato
Natural brass not lacquered



Ottocento

battiporta
door knockers

materiale: ottone
material: brass

KOT215

Ottone naturale non verniciato
Natural brass not lacquered

Ottone lucido verniciato
Lacquered polished brass

Bronzo non verniciato
Bronze not lacquered

Bronzo verniciato
Lacquered bronze

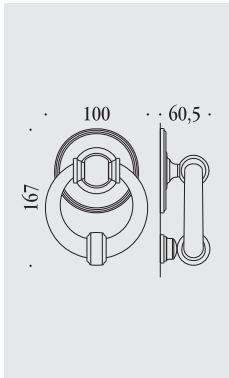

Bronzo non verniciato
Bronze not lacquered



