

# PATRICK

Design: Cà Nova Design



## Product description

Upholstered bed covered in fabric, synthetic nubuck, micro nubuck, synthetic leather or soft leather as per sample card. Polished stainless steel feet. Slats included. Optional: pull-up slats with container.

# PATRICK

Design: Cà Nova Design

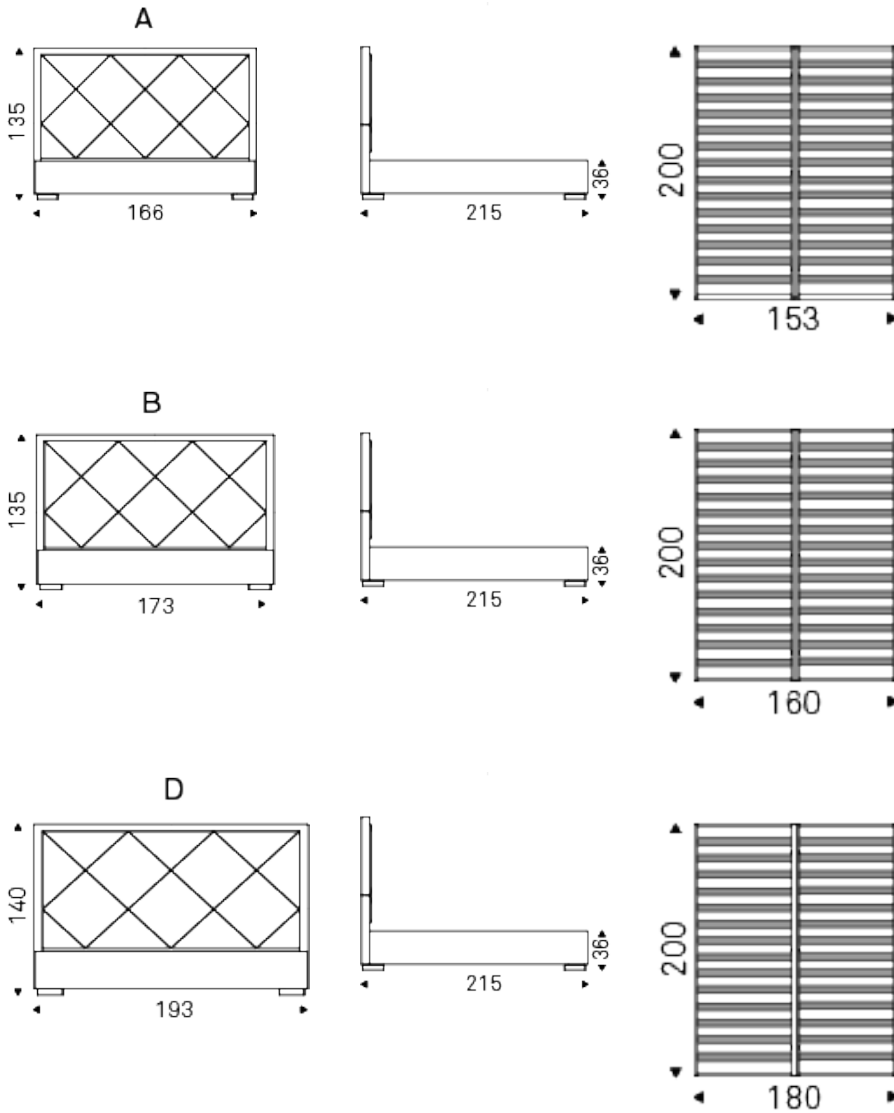

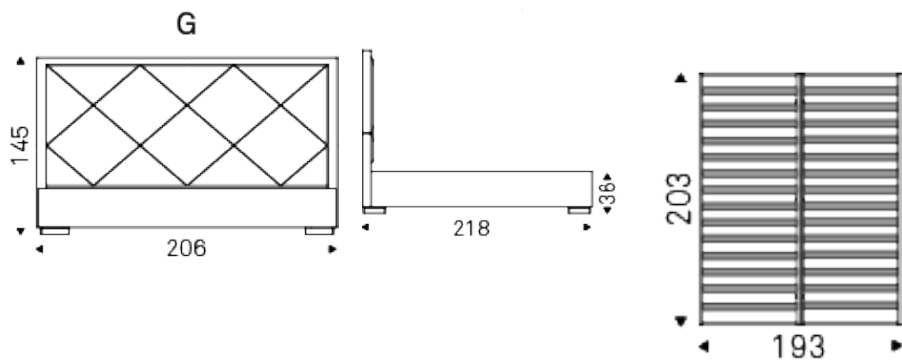
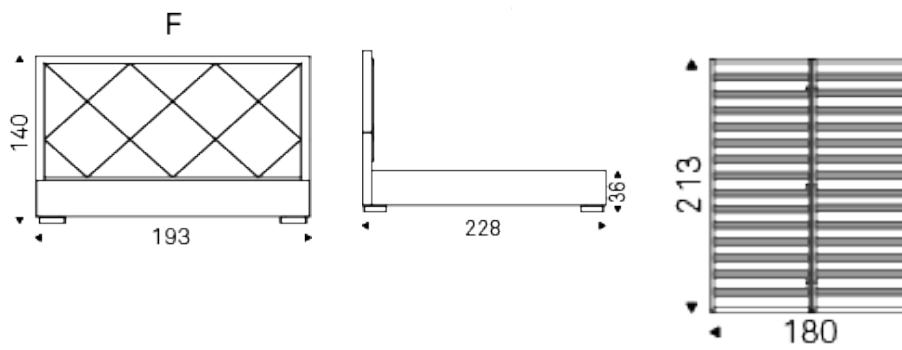
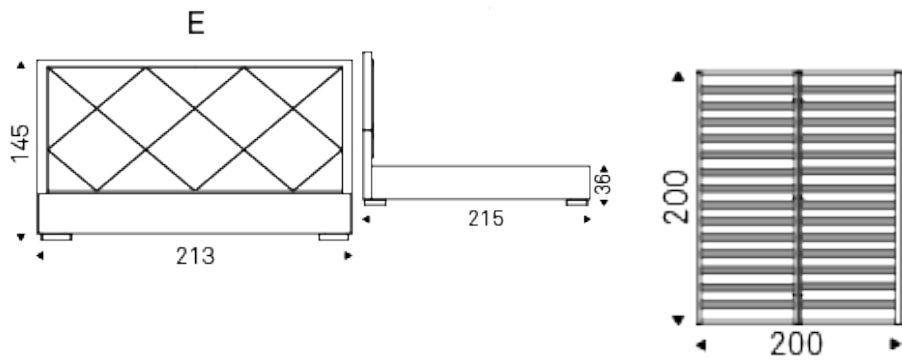

## PATRICK

Design: Cà Nova Design

Finishes: pull-up slats with container

*soft leather*



891 TESTA DI  
MORO

941 RUBINO

942 FANGO

943 MOKA

944 BORDEAUX

945 SAFARI

946 MARRONE

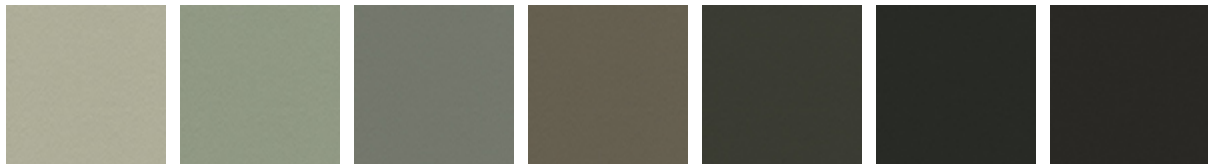

947 OYSTER

948 LINO

949 CENERE

950 TORTORA

951 CASTORO

952 SMOKE

953 ARDESIA



955 MORA

956 ATLANTICO

959 ICE

960 BRUNO

961 LATTE

967 AVORIO

971 BIANCO

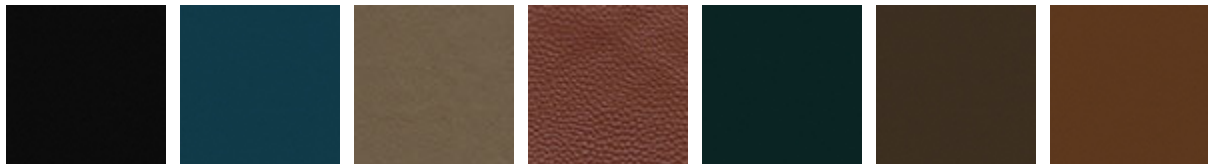

973 NERO

974 CAPRI

975 KAKI

976 ETRUSCO

980 OTTANIO

981 BISCOTTO

982 COGNAC

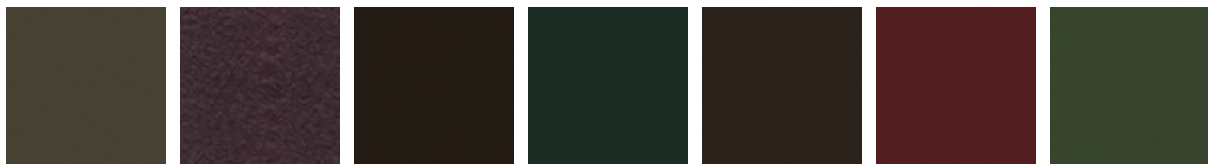

983 ARGILLA

984 BRONZO

985 RESINA

987 SHERWOOD

988 TABACCO

989 ROSSO  
CORSA

990 SALVIA



992 LOBSTER



993 ARTICO

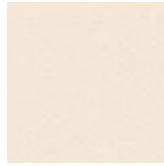

997 PANNA

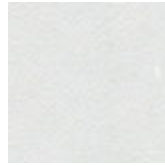

PL71 BIANCO  
PERLATO LUCIDO



PL73 NERO  
PERLATO LUCIDO

*fabric*



B100



B101



B102

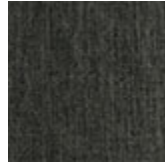

B103



B104



B107



B200



B201



B202



B203



B204



B205



B207

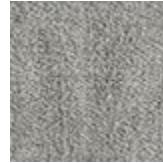

B300

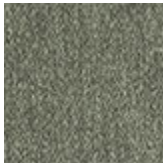

B301



B302



B303



B306



B307

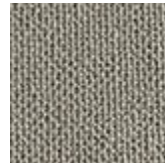

B309

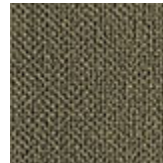

B310



B400

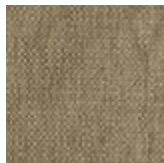

B401



B402



B403

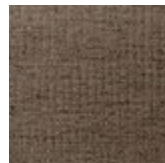

B404

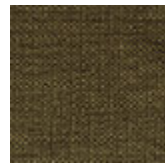

B405

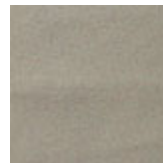

B500



B501



B502



B503



B504

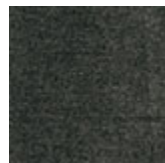

B506



B600

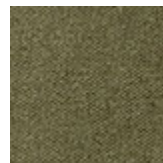

B601



B602



B700

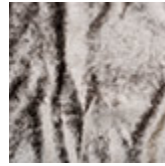

B701

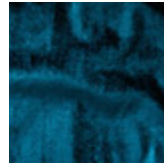

B702

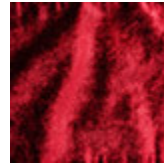

B703

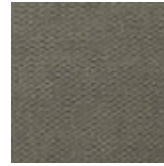

B800



B801

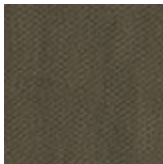

B802

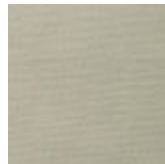

B803

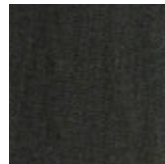

B804

## *synthetic leather*

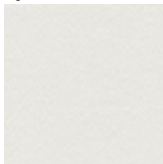

ECP01 BIANCO

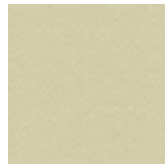

ECP03 PANNA



ECP04 BEIGE



ECP05 TORTORA



ECP07  
MARRONE



ECP08 MOKA



ECP12 ARANCIO



ECP13 ROSSO  
CORSA



ECP14  
BORDEAUX

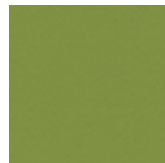

ECP17 VERDE



ECP18 OLIVA



ECP20 CIELO



ECP21 OCEAN



ECP23 LONDON



ECP24 NERO

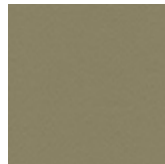

ECP25 CANAPA



ECP26 FANGO



ECP29 CEDRO



ECP33 MORA



ECP36 CEMENTO



ECP37 ARDESIA

## *synthetic nubuck*

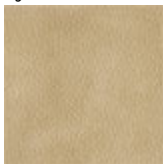

SN01 ZENZERO

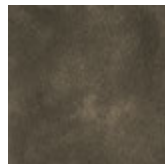

SN03 ARGILLA

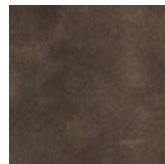

SN04 TERRA

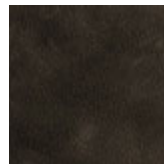

SN05 VISIONE



SN06 VULCANO

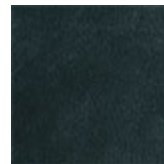

SN17 NOTTE

## *micro nubuck*



## Finishes: fix slats

### *soft leather*





992 LOBSTER



993 ARTICO

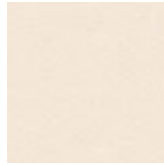

997 PANNA

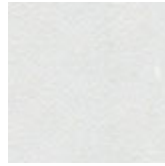

PL71 BIANCO  
PERLATO LUCIDO



PL73 NERO  
PERLATO LUCIDO

*fabric*



B100



B101



B102



B103

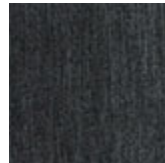

B104

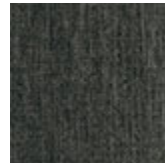

B107



B200

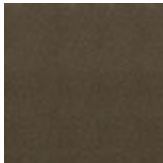

B201



B202

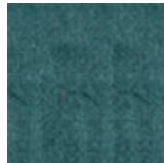

B203

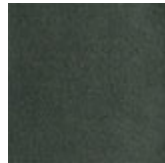

B204

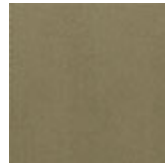

B205

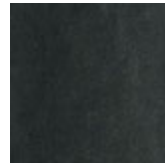

B207

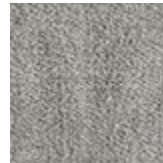

B300

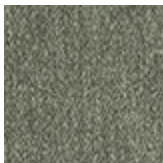

B301



B302



B303



B306

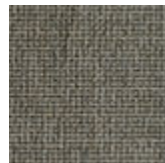

B307



B309

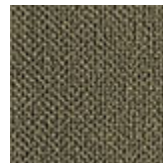

B310



B400

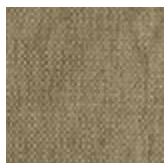

B401

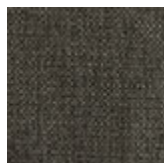

B402



B403

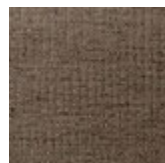

B404

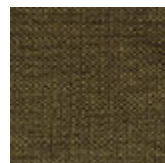

B405

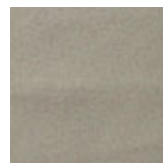

B500



B501



B502



B503



B504

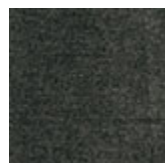

B506



B600

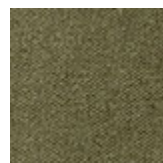

B601





B602



B700



B701

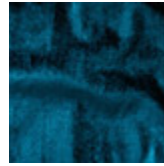

B702

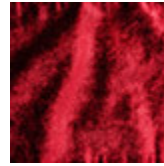

B703

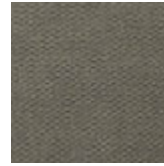

B800



B801

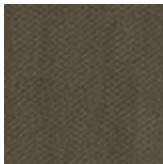

B802

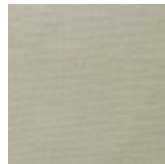

B803

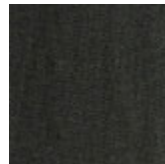

B804

## *synthetic leather*

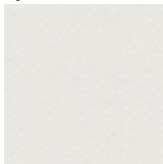

ECP01 BIANCO

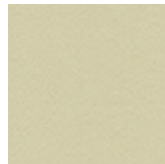

ECP03 PANNA



ECP04 BEIGE

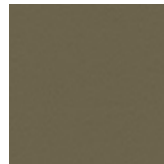

ECP05 TORTORA



ECP07  
MARRONE



ECP08 MOKA



ECP12 ARANCIO



ECP13 ROSSO  
CORSA



ECP14  
BORDEAUX



ECP17 VERDE



ECP18 OLIVA



ECP20 CIELO



ECP21 OCEAN



ECP23 LONDON



ECP24 NERO

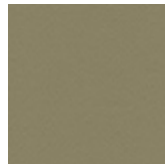

ECP25 CANAPA



ECP26 FANGO



ECP29 CEDRO



ECP33 MORA



ECP36 CEMENTO



ECP37 ARDESIA

## *synthetic nubuck*

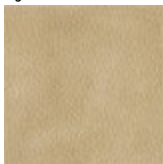

SN01 ZENZERO

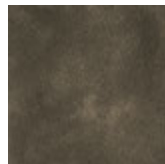

SN03 ARGILLA

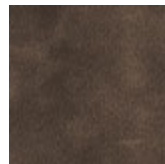

SN04 TERRA

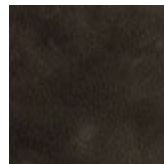

SN05 VISIONE



SN06 VULCANO

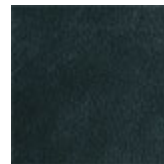

SN17 NOTTE

## *micro nubuck*

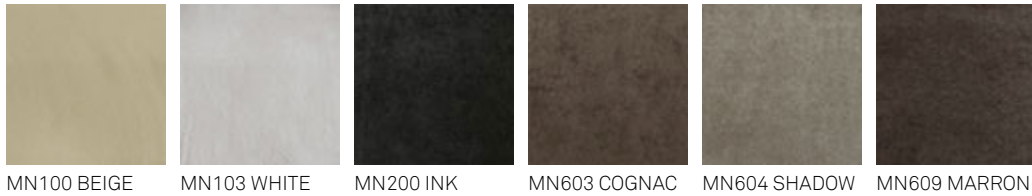

## Finishes: headboard only

### *soft leather*





992 LOBSTER



993 ARTICO

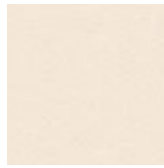

997 PANNA

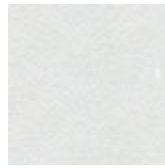

PL71 BIANCO  
PERLATO LUCIDO



PL73 NERO  
PERLATO LUCIDO

*fabric*



B100



B101



B102



B103

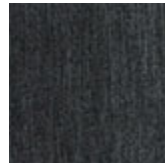

B104

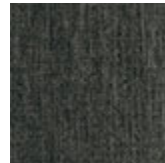

B107



B200

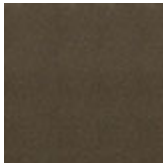

B201



B202

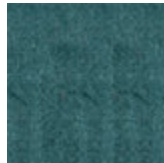

B203

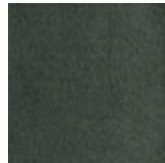

B204

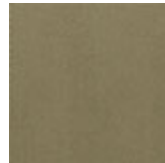

B205

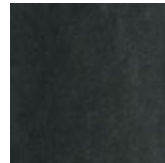

B207

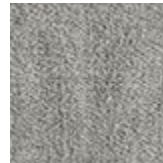

B300

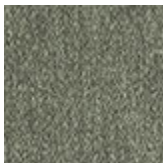

B301



B302



B303



B306

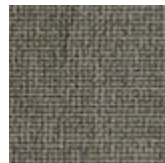

B307



B309

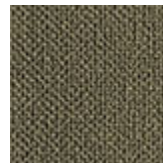

B310



B400



B401

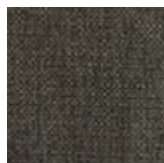

B402



B403

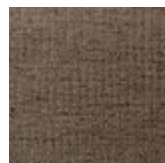

B404

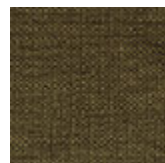

B405

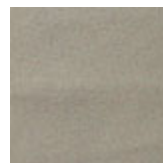

B500



B501



B502



B503

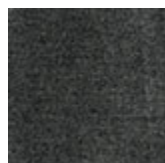

B504

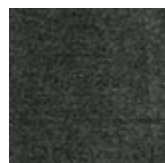

B506



B600

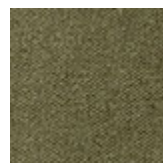

B601



B602



B700

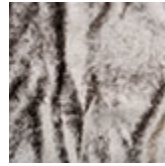

B701

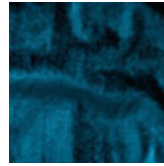

B702

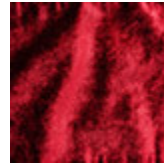

B703

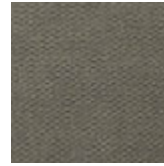

B800



B801

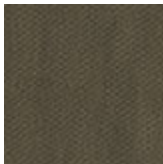

B802

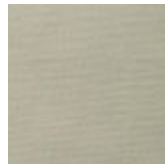

B803

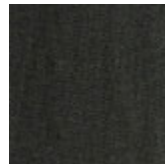

B804

## *synthetic leather*

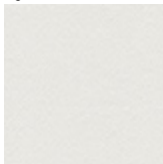

ECP01 BIANCO

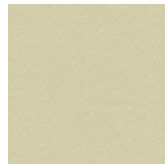

ECP03 PANNA



ECP04 BEIGE

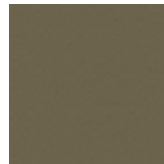

ECP05 TORTORA



ECP07  
MARRONE



ECP08 MOKA



ECP12 ARANCIO

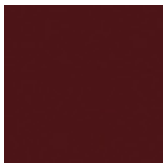

ECP13 ROSSO  
CORSA



ECP14  
BORDEAUX

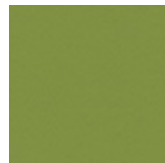

ECP17 VERDE



ECP18 OLIVA



ECP20 CIELO



ECP21 OCEAN



ECP23 LONDON

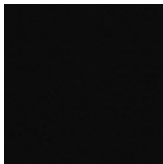

ECP24 NERO

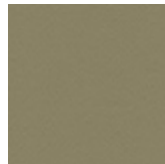

ECP25 CANAPA



ECP26 FANGO



ECP29 CEDRO



ECP33 MORA



ECP36 CEMENTO



ECP37 ARDESIA

## *synthetic nubuck*

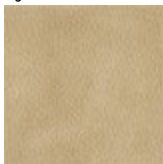

SN01 ZENZERO

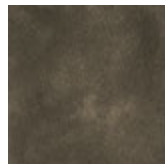

SN03 ARGILLA

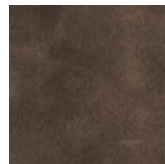

SN04 TERRA

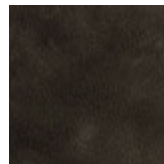

SN05 VISIONE



SN06 VULCANO

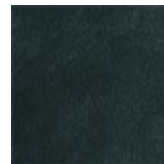

SN17 NOTTE

## *micro nubuck*



MN100 BEIGE



MN103 WHITE

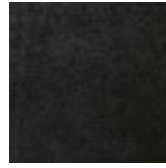

MN200 INK

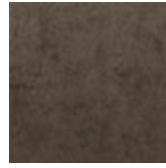

MN603 COGNAC



MN604 SHADOW

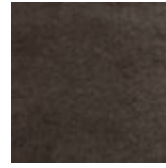

MN609 MARRON

## GENERAL TERMS AND MAINTENANCE

The **SOFT LEATHER** is a natural material. A non uniformity in the wrinkle's drawing and small defects must be considered a feature that certifies the quality of leather. The leather undergo over time a slight discoloration, either with exposure to direct sunlight or to sources of heat. Be careful with straps, studs, buttons or other sharp metal objects that could scar the surfaces.

**MAINTENANCE:** It is a good practice to remove the dust, which often clogs the pores, not allowing the natural perspiration. Always use a soft, dry cloth. Avoid using brushes that can damage the surface. The removal of stain is extremely difficult as in the case of grease spots, ink and alcohol. Good results can be obtained by acting promptly with soapy water or mild detergent, rinse and wipe dry immediately with a soft cloth. Avoid alcohol, acetone, trichlorethylene, detergents or abrasives.

**CATTELAN ITALIA LEATHERS** are produced with selected cow leathers, tanned and dyed with products that do not contain substances harmful to human health, in full compliance with the current regulations.

**MAINTENANCE:** see the instructions for the soft leather.

The **SYNTHETIC LEATHER** (or false leather or vin-leather) is a special ecological fabric similar to leather or hide even if not realized with animal material. Has excellent physiological and hygienic qualities and is harmless from the toxicological point of view. It does not cause dust allergies. High resilience is finally a good guarantee of durability. It is also self-extinguishing, and reliable with regards to the safety. It's a product Made in Italy. **MAINTENANCE:** requires no special care. In case of stains wipe with a damp cloth. Use neutral specific products. Do not use brushes, grease, petrol or acetone which will damage the surfaces.

**FABRICS / SYNTHETIC NABUK:** With regard to the fiber content, technical specifications and maintenance instructions, please refer to the information available by the authorized dealer.

**PAINT, LACQUER AND EMBOSSED PAINT:** the main features are light and corrosion resistant. The embossed painting also makes the surface more resistant to scratches, thanks to its grainy film.

**MAINTENANCE:** For normal cleaning, use a slightly damp soft cloth. Do not use abrasive cleaners, solvents, ammonia, acetone. In case of stains, remove them with a solution of mild soap and water, taking care to dry the wet surfaces.

The **WOOD** that is used for all CATTELAN ITALIA products is sourced only from the finest ecologically sustainable forest plantations and each piece has been treated using the least invasive processes as not to affect its natural beauty, but importantly guarantees the longevity and durability over the years of use. Wood is a natural material and as such, it will continue to change in appearance which will further enhance its natural look. Minor variations of tone, the presence of knots, veins and burn marks are all testament to the uniqueness and authenticity that each piece of wood will possess. **MAINTENANCE:** Please read the care instructions for lacquer.

**LAMINATE** is a material highly resistant to shocks, water, steam, heat, stains, light, and chemical agents.

**MAINTENANCE:** To remove stubborn stains use a damp cloth with water and liquid detergent.

**MARBLE AND NATURAL STONES** are protected by a layer of water-oil repellent that protects surfaces. The lead polishing gives to the slab's surface gloss and resistance to light and hard weather conditions, which gives a guarantee of excellent durability.

**MAINTENANCE:** For proper cleaning and surface protection of natural stone or granite use specific products according to their use. Do not use harsh detergents that can dull the surface and affect the water-oil repellent treatment. It is advisable to clean, protect and polish only with specific products for natural stone or granite for a long term durability.

The making of the **CERAMIC** used for all CATTELAN ITALIA ceramic tables is an innovative process. It begins with the wet grinding of natural materials such as clay, granite and ceramic particles that are in powder form, which then are all compacted down together in a process known as 'firing'. **MAINTENANCE:** Ceramic tops should be cleaned with a wet sponge and a mild detergent. Do not use abrasive cleaning products. Do not use a steam cleaner. For best results, it is recommended that you use a limestone cleaning gel. It is best to remove fresh stains as quickly as possible as there is the potential risk that over time the stain can penetrate the pores of the ceramic. In the event that a stain has been present on the ceramic for some time, use a solution mixed from bicarbonate soda and water. Rub the surface, allowing the solution to penetrate the stain, and then wipe it off with a wet sponge. **GLASS and MIRRORS,** all glass, tempered or not, have safety features such as to match the requirements.

**MAINTENANCE:** Avoid using abrasive materials that can damage the surface permanently. For the mirrors, it is recommended to use only a soft cloth dampened with alcohol.

**POLYURETHANE** belongs to a large class of compounds called polymers. Polyurethane is made through a process known as 'condensation' which allows the polyurethane to be moulded into any shape. Once the process of condensation is complete and the desired shape has been formed, the end result is that the shaped cannot be unchanged. As a result and by using the right elements, the desired requirement of softness and comfort can be met. **MAINTENANCE:** For normal cleaning, use a damp cloth. Do not use abrasive cleaning products such as ammonia or solvents. To remove spots, use a solution mixed from water and mild soap and ensure that you dry the affected area immediately after wiping it.

### INSTRUCTIONS

If you must assemble components, follow all instructions included in the packaging. Screws, bolts and other fastening parts should preferably be tightened by hand. Do not use power tools. In case of difficulty, please contact your dealer for any assistance. Do not use the product for uses other than those related to the category it belong.

### DISPOSAL

After use do not dispose of the furniture in the environment. Entrust to specialized companies for the recovery and / or disposal.

### WARRANTY

This Certificate of Guarantee apply to all CATTELAN ITALIA products, and is valid only in cases where the item purchased is defective or fails to fulfill compliance to the objective descriptions and aspects of quality and performance made by the seller or the producer. The warranty applies to the product up to 2 years after delivery. The warranty is supplied at the moment of the sale, and is valid only in the presence of data and stamp of the dealer, the bill of lading or receipt. The warranty is valid only for defects of conformity existing at the delivery thereof and excludes any other type of defect source later if not objectively recognized. Are also excluded from application of the Warranty Certificate the following aspects: transport damage, damage or breakdown products as a result of improper handling and / or storage at the warehouse store or distributor, faults and deterioration from use, scratches and abrasions, stains, exposure to water, direct sunlight, excessive heat or cold, vandalism, misuse, misapplication and / or incorrect use of the product, improper handling of materials. Are also excluded from the guarantee products made from materials supplied by the customer and tampering or attempted repair of the goods without written permission by CATTELAN ITALIA.

These information are based on data published in our latest pricelist. Cattelan Italia reserves the right to change or improve any product without any notice.