

Orten'zia, Petals of *Light.*

Recalling the natural beauty of a flower, Orten'zia hand-soldered "petals" emanate a unique glow, immersing the entire room in a glimmering light. An organic radiance is created through light and shadow, planting a garden within the room. Available in either nickel or gold plated, the orten'zia's elegant form complements its dramatic light. Design Bruno Rainaldi.













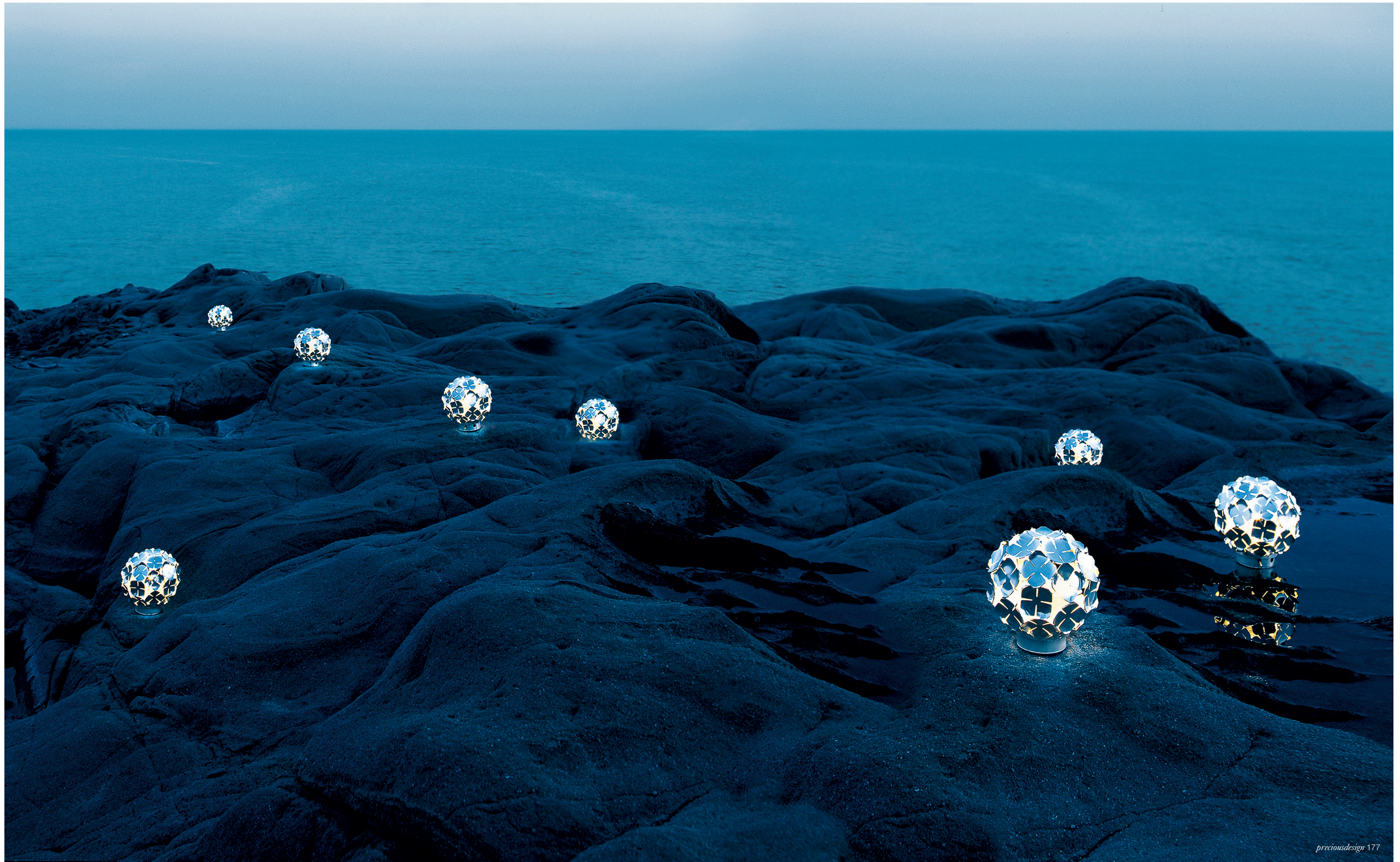



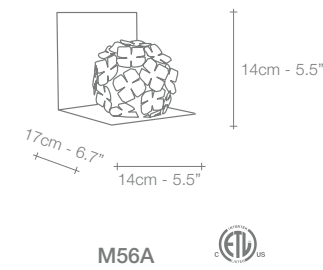
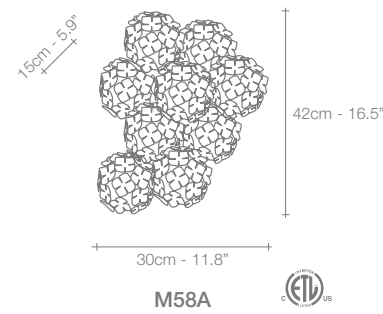
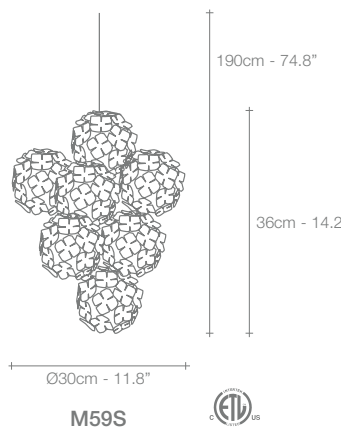
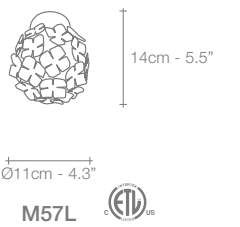
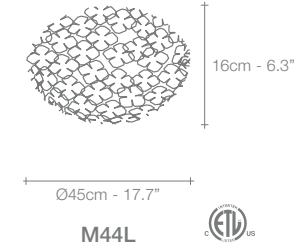
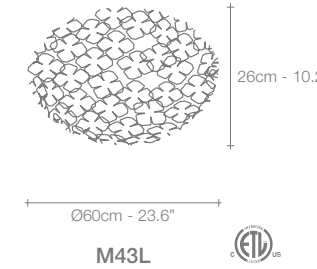
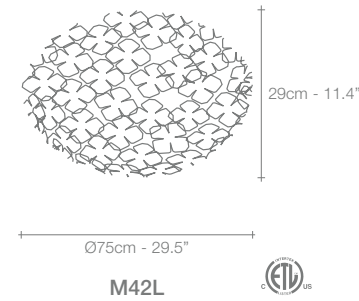
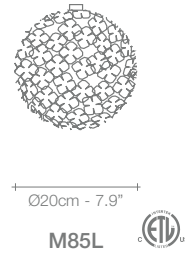
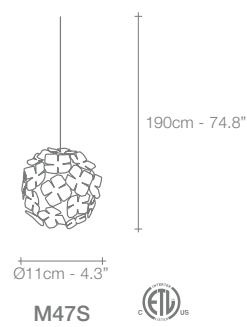
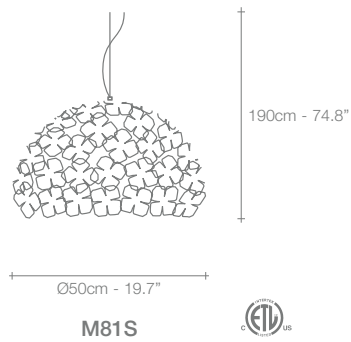
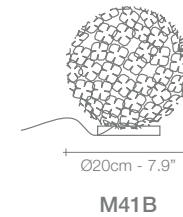
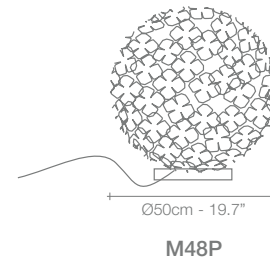
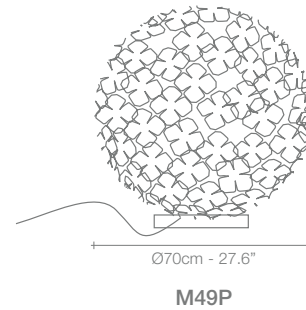
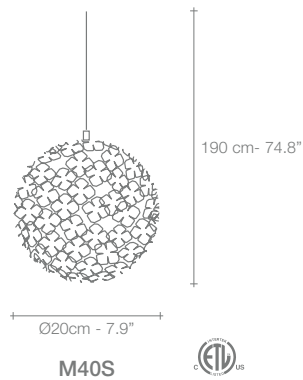
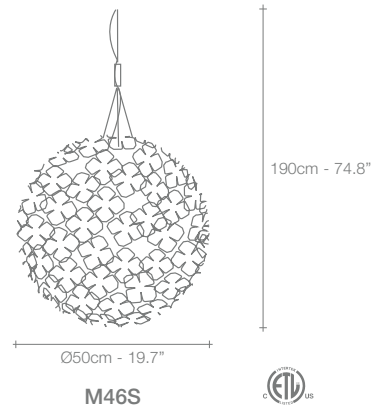
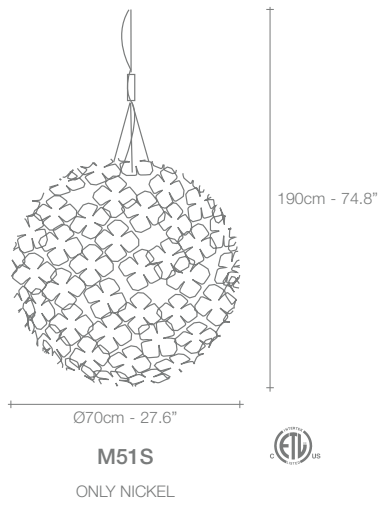

230V		M40S	M41B		M42L	M43L	M46S	M48P	M49P	M51S		M44L		M50B
	HALOGEN ES E14	42W (=60W)	42W (=60W)		HALOGEN ES E27	140W (=200W)	105W (=150W)	140W (=200W)	105W (=150W)	140W (=200W)		140W (=200W)		HALOGEN ES R7S
120V		M40S	M41B		M42L	M43L	M46S	M48P	M49P	M51S		M44L		M50B
	KX-2000 T3 E12	40W	40W		CLEAR STD. TYPE A E26	A23 200W	A23 200W	A23 200W	A21 150W	A23 200W		A23 200W		HALOGEN J-SHORT R7S

230V		M47S	M56A	M57L	M58A	M59S	M85L		M81S
	HALOGEN ES G9	48W (=60W)	48W (=60W)	33W (=40W)	5X33W (=5X40W)	60W (=75W)	33W (=40W)		COMPACT FLUO. E27
120V		M47S	M56A	M57L	M58A	M59S	M85L		M81S
	HALOGEN JCD G9	50W	50W	50W	5X35W	50W	35W		GLOBE G40 E26